

NEMESIS 9100

Universal Hardness Tester | Vickers, Knoop, Brinell, Rockwell

AUTOMATIC / FULLY AUTOMATED



NEMESIS 9100





Truly Universal...

The NEMESIS 9100 Series Universal Hardness testing systems provide exceptional performance and are designed with enhancements that deliver unparalleled accuracy and reliability, improved ergonomics and an overall enhanced and pleasant experience for the operator. The IMPRESSIONS™ tester control and work flow software, forms an integral component of the testing system. Decreasing set up time and increasing testing efficiency through the use of programmable test patterns and specific designed software applications, developed upon the request of demanding users.

NEMESIS 9100 hardness testing instruments are routinely used for testing metals and plastics, in the aerospace and automotive industry, laboratories for sample evaluation, or to conduct common but versatile testing tasks.



HARDNESS SCALES

- 
VICKERS 200gf - 150kgf
also HVD (HVT)
- 
KNOOP 200gf - 5kgf
- 
BRINELL 1kgf - 3000kgf
also HBD (HBT)
- 
ROCKWELL 3kgf - 150kgf

* For more details on the scales see page 30

TECHNOLOGY OF TODAY

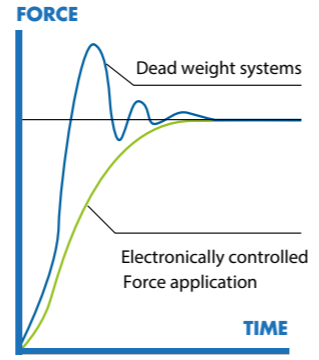

Load cell, closed loop, force feedback system

A FORCE RANGE, THAT HASN'T BEEN DONE BEFORE!

1gf	500gf	250kgf	NEMESIS 9101	3000kgf
1gf	200gf	250kgf	NEMESIS 9102	3000kgf
1gf	5kgf		NEMESIS 9103	3000kgf
1gf	200gf		NEMESIS 9104	3000kgf

HIGHLIGHTS

- 1 Multi Load Cell, Closed Loop force application system, error <0,25%
- 2 Descending test head, with fixed work piece position
- 3 8-position turret with **standard built-in laser positioning system**
- 4 3 indenter positions, 3 LWD objectives installed (included)
- 5 18 megapixels, 4K+, full color, integrated camera system
- 6 Quick change anvil post & CNC motorized XY-stages, variable stage dimensions and travel ways
- 7 Full XY-stage overview camera, optical zoom system, with variable field of view
- 8 TTL power LED, Dual source power LED bank, stage illumination
- 9 Z-axis with ball bearing spindle
- 10 Integrated or external high performance system controller, i7 processor, 120GB mSSD storage
- 11 Industrial 15" touchscreen, option for second screen 15" to 55" or projector
- 12 Top-class replaceable body parts, shock proof ABS covers

Crossing all boundaries...

1 8 POSITION PRECISION TURRET & LASER POSITIONING

The 8 position turret is supplied as a standard feature on all 9100 models and allows to install indenters for Rockwell, Vickers, Knoop and Brinell (balls 1mm, 2.5mm, 5mm & 10mm) testing. Factory installed, the NEMESIS 9100 has 3 standard objectives 0.7x, 2.5x, 10x and a built-in Laser Positioning system.

2 STAGE OVERVIEW CAMERA (OPTIONAL)

Create magnified sample overview with the optional integrated auto focus optical & digital zoom, overview camera. The field of view of this sophisticated full color camera system does not limit you to one field of view, but gives a ZOOM range of 40 x 30 mm up to 210 x 160 mm without the need to use time-consuming scan and stitch functions.

Once the viewing area needs to be larger than the zoom range, scanning and stitching can be selected to create full stage overview. Click and go is one of the standard testing features of the overview camera. Just click randomly on designated area's and push "start". All tests run automatically. The pattern video overlay function eases positioning of multiple test rows or patterns across the specimen. The pattern video overlay scales automatically with every magnification, stepless, while the zoom camera decreases or enlarges the overview.

3 DYNAMIC Z-AXIS CONTROL & COLLISION DETECTION

A high end ball bearing Z-axis spindle is one of the very unique functions. Z-axis displacement at an accuracy of micron's supports ultra-fast auto focus. Z-axis controls are nearly limitless; CNC as a result from a test program, by touchscreen indicators, from the built in joy stick, by the scroll wheel of the mouse, by fast up and down buttons or from a scroll wheel on the front of the machine. Positioning has never been this easy. Speed control related to your own movement; (0.01 up to 20 mm/s). To avoid any collision between the work piece and the turret, the Z-axis is controlled by a flawless collision detection and Z-axis retraction system. So neither the tester nor the workpiece are exposed to any damage.

4 HIGH SPEED CNC MOTORIZED XY-STAGE (OPTIONAL)

Save time and improve efficiency with one of the high speed, highly accurate motorized XY-stages. Available in variable sizes from standard, to large and extra-large. Enable automated sequencing of multiple samples. The ultra-high accuracy and repeatability guarantee precise positioning of indents and allow re-evaluation of any measurement points in batch or single view. Repeatability within 3 micron.



CONNECTIVITY, CONTROL & QUALITY ASSURANCE

The system has bi-directional in and output channels. Tester control can be conducted remotely and supports for instance, but not limited to robotic systems. Test values can be exported as single values or as string of data to be handled by 3rd party quality evaluation software.

Q-DAS certified. (Optional)

5 15" HD TOUCHSCREEN OPERATOR INTERFACE

All machine control and workflow process can easily be operated from the 15" industrial capacitive touchscreen. At choice a second 15" or larger screen can be connected.

6 SHOCK RESISTANT ABS MACHINE COVERS

The tester is fitted with a high-end external shell structure. All in a unique design with high-end aluminium panels. The shock proof and damage resistant ABS machine covers can withstand the harshest environment.

THE POWER OF INNOVATION

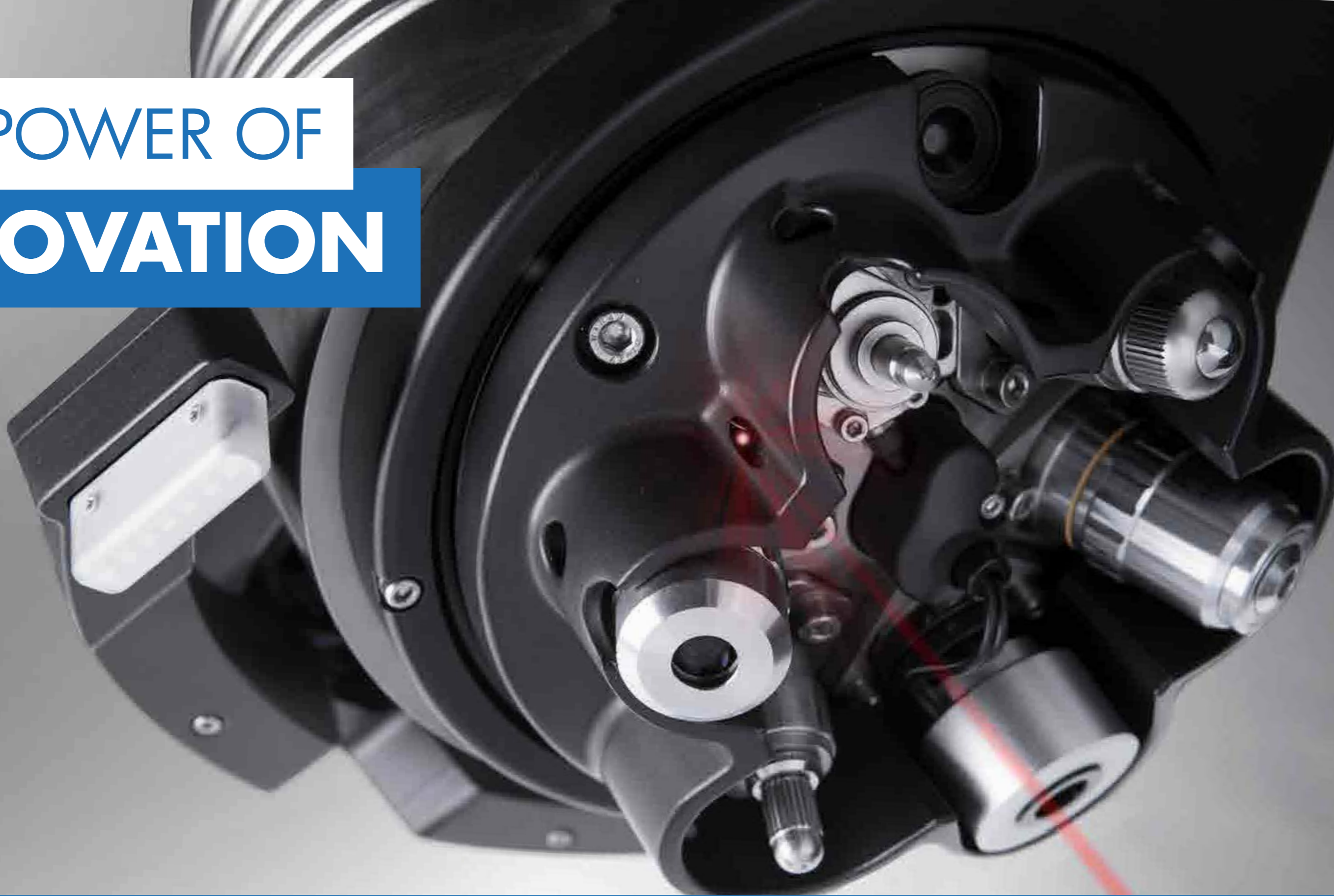

It's not about ideas, it's about making ideas happen...

Sophisticated and unique, 100% linear, vertical force actuator. Cutting edge technology, high speed turret with integrated multi load cell signal handling, stage overview camera at indenter position, power LED TTL illumination, positioning laser and an advanced collision detection and test head retraction system.

TURRET TECHNOLOGY

The high speed 8 position turret or revolver is the main center of performance of the NEMESIS 9100 series.

Designed for test forces up to 3000kgf in the NEMESIS 9100 configuration, this masterpiece of mechanics and optics also incorporates load cells and electronics to handle all force application and force system feedback.

It's also the home base of the high definition overview camera equipped with optical zoom system and autofocus, at indenter position. The technology of this camera provides a variable field of view of the overview, not seen in the industry before. Time consuming image stitching is therefore not required for most common samples.



1 POWER LED BANKS

On the side of the turret, two power LED banks, mounted at a distance, provide cross surface illumination, assuring that the overview system has excellent viewing performance under all circumstances and on all materials.

2 3 OBJECTIVES

The three long working distance objectives mounted on the turret as a standard accessory, channel images to the built in 18 megapixels, full color, 4k+ camera system. The result is a bright, sparkling image of your indent, the start of a successful precise automatic measurement function.

3 LASER POSITIONING SYSTEM

Another feature, not seen before in this class of instruments, is the standard, Class 2 laser positioning system. Position parts with great precision at the exact indent position. Provides operator comfort without limitations.



4 PROTECTION SYSTEM

Protecting the turret, load cells, optics and other parts, but also the workpiece against collisions caused by operator failure or program failure, the turret has a highly sensitive collision detection and retraction system. Broken indenters or damaged optics are simply history.

The system also recognizes unintended resistance that could be caused from hands or fingers and will retract the test head in any suspect situation instantly.

The turret also has a ridged protection parts for possible hits caused by positioning of the to be tested. The skirt mounted on the rotating center of the turret protects each individual turret position against accidental damage.

Vertical force actuator with position reading system

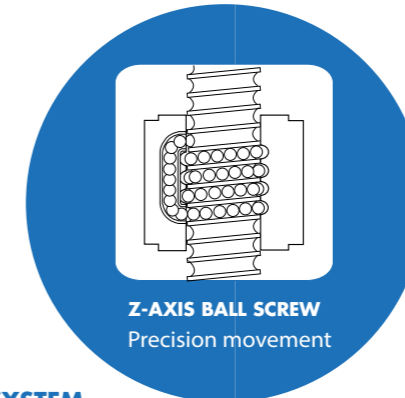

Servo Drive System for low force models

MULTI LOAD CELL SYSTEM

To cover the wide range of test forces the low force models have three load cells installed. Each with its specific force range. Only in this way, high force accuracy and repeatability are always guaranteed.

POSITION READING SYSTEM

The force actuator with a stroke of 320 mm has a linear reading system (glass scale) manufactured by HEIDENHAIN Germany. This top quality system with ABS position reading, provides a constant loop of information on the position of the test head and communicates details of the position that are used for rapid autofocus. This system enables you to conduct comprehensive depth measurement methods such as HVD (HVT) and HBD (HBT) normally not available on Micro Vickers / Vickers hardness testing machines.

SERVO DRIVE SYSTEM

The actuator is empowered by a high quality servo drive system. The system provides constant feedback on load, speed, resistance and other parameters that influence the operating process and tester integrity. At a central position in the force actuator, a ball bearing spindle translates the servo rotation to the operator desired direction or test cycle. Tester control and performance at the highest level.

The advantage of the descending test head over traditional spindle machines is the ease of handling larger parts and the fixed height of the workpiece position. Traditional spindle machines usually have a trapezoid spindle, that offers little accuracy on position, a wobbly image and a slower autofocus function.

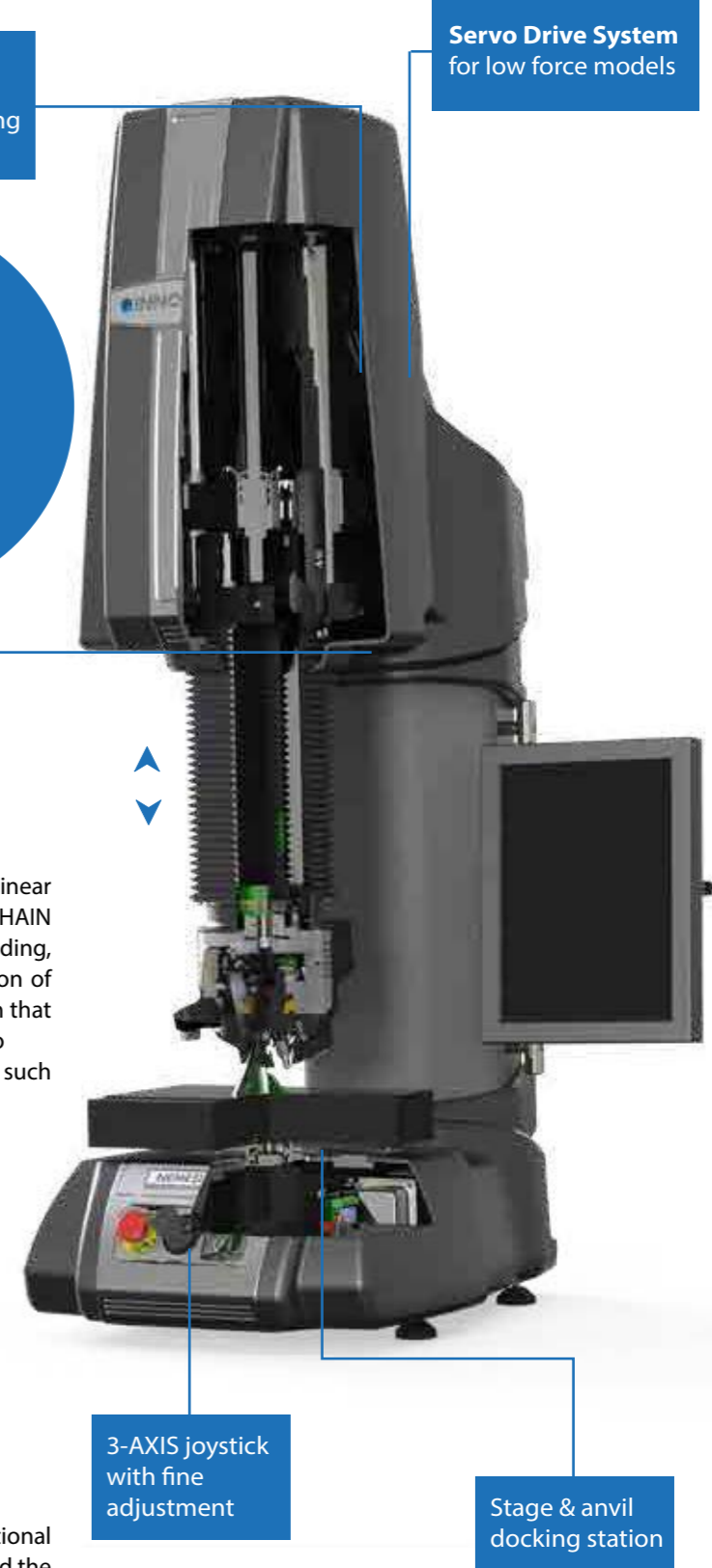

AUTOMATIC IMAGE EVALUATION



1

1 AUTO FOCUS

Fast & precise, observe how IMPRESSIONS™ finds focus from a large distance, as far as the travel of the Z-axis allows. Algorithms used for close distance autofocusing set new standards in AF speed.

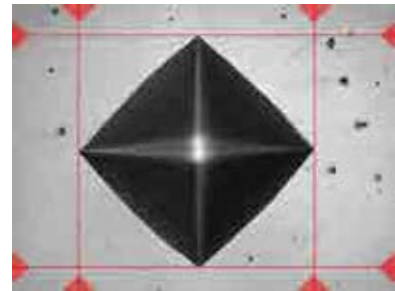

2

2 AUTOMATIC MEASUREMENT

Manual positioning of filar lines is no longer required. IMPRESSIONS™ refined measurement algorithms detect indents even on very poor or scratched surfaces and measure the relevant indent dimensions according to standards. Stay in control by switching to manual measure mode and have the option of adjusting measurements by touching the screen or using the mouse. Filar lines can be colored to give the best contrast against the specimen's surface. To assure that measurements meet relevant standards on symmetry, enable the automatic indent check. All hardness values can be converted to other scales according to ISO 18265, ISO 50150, ASTM E140.

3 ILLUMINATION SETTINGS

IMPRESSIONS™ software automatic illumination system adapts to the correct illumination regardless of the sample surface quality, wherever on the sample, independent from material (steel, carbide, coated or ceramic). Contrast, Brightness and program, can be set automatically for each measurement or controlled manually. Sharpness can be stored with the pre-determined test

Too bright

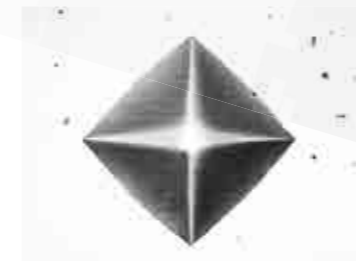

OK

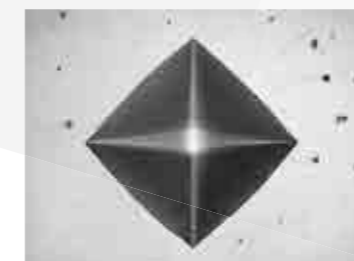

Too dark

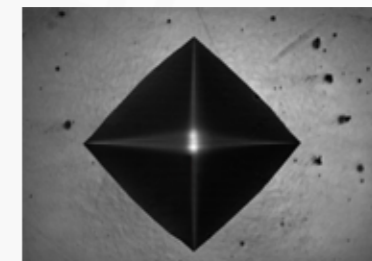

3



Irregular surface

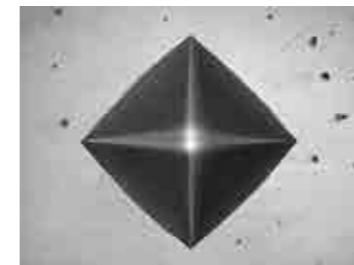

Regular surface

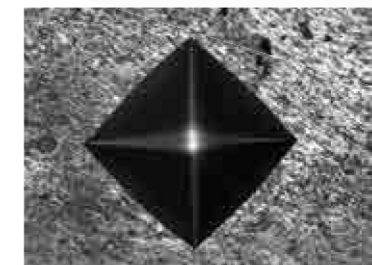

Poor surface

4

4 REFINED IMAGE DETECTION

Complex, refined algorithms ensure reproducible measurements on different materials and even on scratched and damaged surfaces.

One accurate measurement is worth more than 1000 expert opinions...

Science fiction?... No, just reality ahead of schedule

The Graphical User interface (GUI), contains Industry preferred applications, and offers easy to learn, advanced workflow control. A simple test can be set up and conducted in about 3 seconds... IMPRESSIONS™ layout & functions will match not only your particular application requirements, but also meet the needs and preferences of your operators. A user level management system maximizes their comfort and efficiency.

The unique in the industry, 15" portrait mode, capacitive touchscreen, gives room to all possible applications. Dual screen: For demanding users, a second vertical 15" or 24" landscape screen can be connected. For educational purposes, schools, universities, a full HD projector (beamer) can be connected to the HDMI supported outlet. With this many options in Hardware and Software configuration, yearly updates and on demand upgrades, IMPRESSIONS™ is truly the leading software in the industry.



FEATURED BY IMPRESSIONS v2

ADVANCED SOFTWARE APPLICATIONS

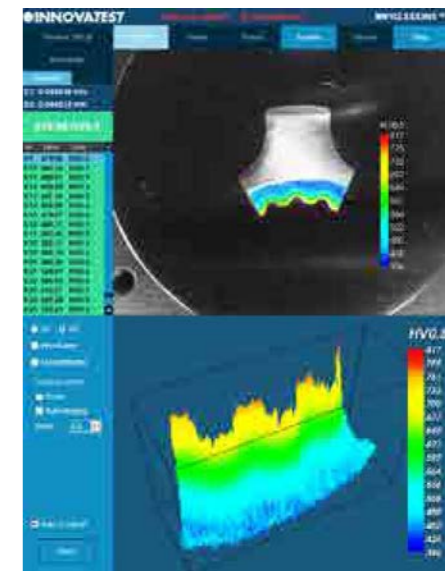
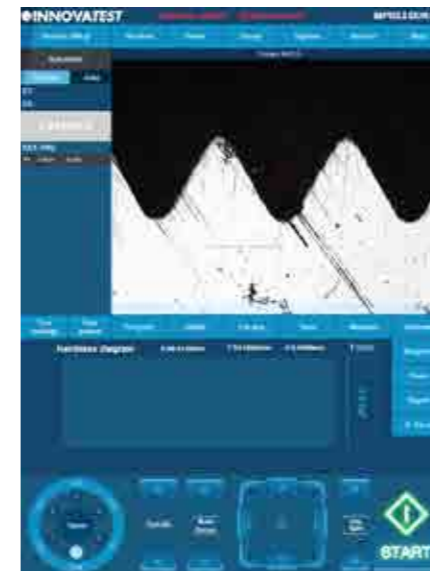



1 PATTERN TESTING

The IMPRESSIONS™ pattern editor allows the user to create any number of test patterns with a large number of variable settings. Create test patterns with great precision and freedom. Verify the settings in the preview mode. Drag & drop patterns from one test sample to another sample. Live vision technique over zoom overview camera, no image stitching required.

Combine different patterns and even different test forces in one program, and run them fully automatically. All test points can be identified individually or to customer specifications. The label is shown in the test result list and in the test results overview and in the results print out. An important function for sample analyses at the end of a test and in the future for review of previous tests.

2 CHD, SHD, NHD

How do you increase throughput in your lab? Make the most common testing design as easy to set up as it is to perform automatically and still adhere to the applicable standards. CHD/SHD/NHD testing can be started directly from the surface view or from the overview. Additional core points of hardness can be defined separately for NHD measurements. The distances of test points are automatically set to a minimum distance, following the standard, to assure correct testing is conducted. Time saving test mode "complete all indentations – then evaluate" and "auto-stop" to complete test series as soon as the lower hardness limit has been reached. Report Generator is enhanced with reporting features for this application.

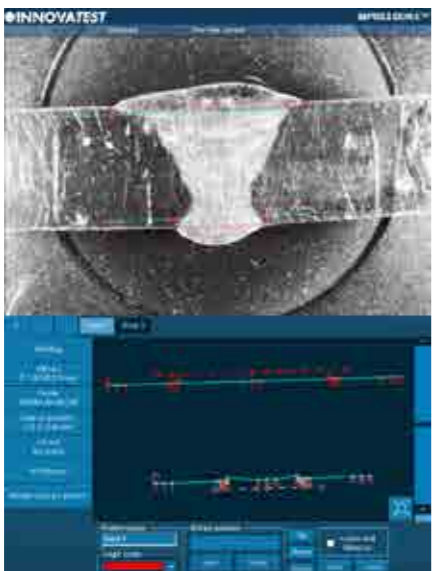
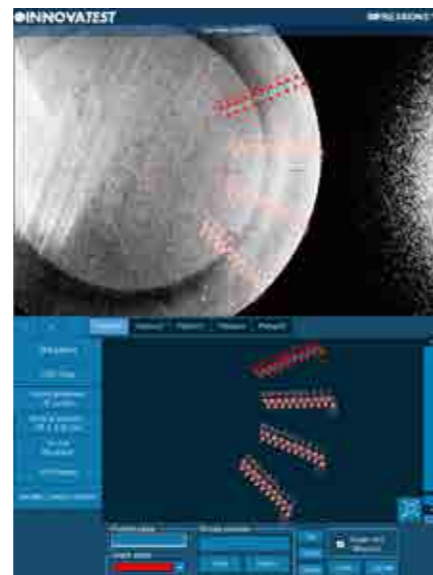

3 WELD INSPECTION (ISO 9015)

This especially developed tool enables you to conduct hardness testing on welded parts or segments according to ISO standard. Setting up the pattern according to the requirements becomes "easy-to-do", due to pre-set test points in the different zones of the weld and automatic correlation between test points. The system will run a fully automatic test procedure and display and record the results accordingly. Report Generator is enhanced with reporting features for this application.

Easy to operate, time reducing solutions...



4 HARDNESS OF SCREW THREAD DECARBONIZED ZONE (ISO 898-1)

A specialized software tool of IMPRESSIONS™ allows you to set up and conduct fully automatic testing as per ISO 898-1 for screw thread measurement of (de)-carbonized part. Report Generator is enhanced with reporting features for this application.

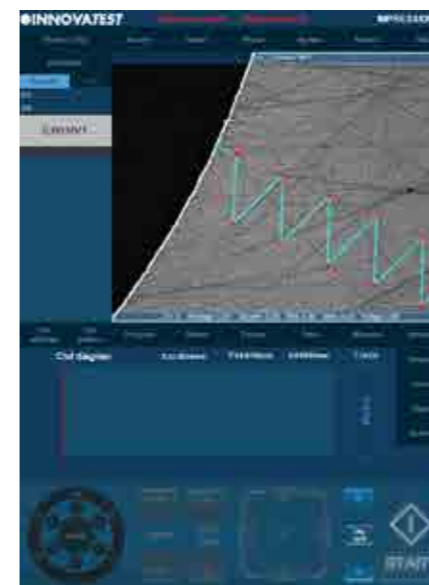

5 EDGE DETECTION

Technology that automatically or at a mouse click recognizes the edge of your sample. This helps to determine and fix the desired starting position for CHD or other pattern testing jobs.



6 AUTOMATIC CONTOUR SCANNING

This application scans the entire outline (or partial) area of a sample. The function can be used with an objective by using the overview zoom camera for high speed scanning. The system scans the entire outline defined and stores all relevant data in the test program.

Subsequently, a limitless number of test points can be inserted into the scanned image, or be set at selected distances (offset), relative to the edge. This advanced feature enables the hardness testing procedure to be performed automatically. An excellent feature to combine with 2D or 3D hardness mapping, also known as "plane hardness chart".

Yes, we can...



7 Kic CRACK MEASUREMENT

For those requiring more in depth knowledge on materials behavior, wishing to study material fracture and fatigue, crack growth can be predicted and measured by using the Kic application. The software supports Kic crack detection under load with customized Kic result reporting. By way of one or both methods, Palmqvist or Median / Radial, fracture toughness is now a repeatable and reproducible test across multiple operators.

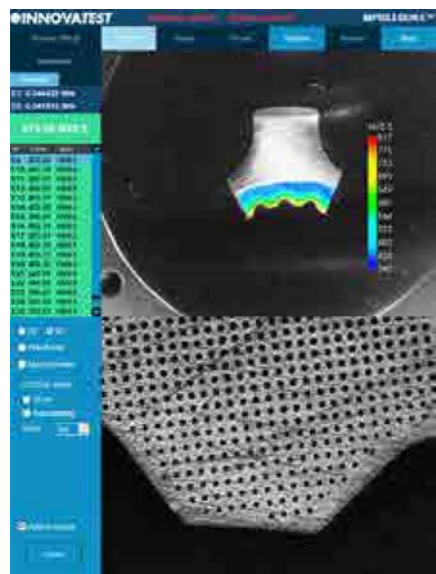

8 2D HARDNESS CHART

The application „Plane hardness chart“, is also referred to as Color Mapping happens to be the perfect tool for securing the detail of the effective hardness distribution over the total sample cross section of heat treated samples. An important feature in material exploration, weld testing or in damage analysis.

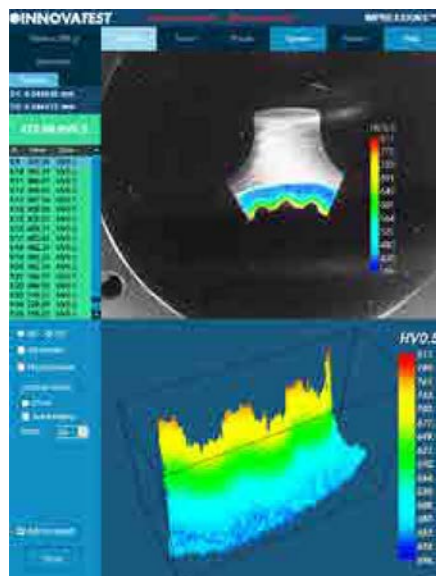

9 3D HARDNESS CHART

In addition to the option to display a 2D graphic diagram, the system can generate a 3D visual as well. 2D and 3D hardness charts are included in one application.

10 SNAPSHOT FUNCTION

This handy function in IMPRESSIONS™ allows you to make screen captures of the viewing area by way of objective view and/or Overview camera. It gives the opportunity to store such images with comments or to paste them into the report generator for further processing.



11 USER DEFINED PROGRAMS

For repeating jobs, IMPRESSIONS™ utilizes the option of setting up and storing custom test programs. For each task, a „job“ can be created. All application specific parameters, like hardness scale, force, dwell-time, pattern, conversion and the report template are stored in the same program.



12 REPORT GENERATOR

Imagine having a report created for you that includes: Your company name, address, contact information, labeled results related to patterns or sequential, pictures of your optical measurements, stitched images, notes section for each result or pictures, rendition of the pattern performed, overview picture of your pattern on your sample, full statistics, summary of your results, go no-go results, Pass or fail...all that information or having the ability to only have what you need reported, we call this our Report Configurator. You decide how much or how little you report by PDF or laser printer. We even keep it simple by choosing export to CSV file, to a thumb drive or network file location. Data management at its best!

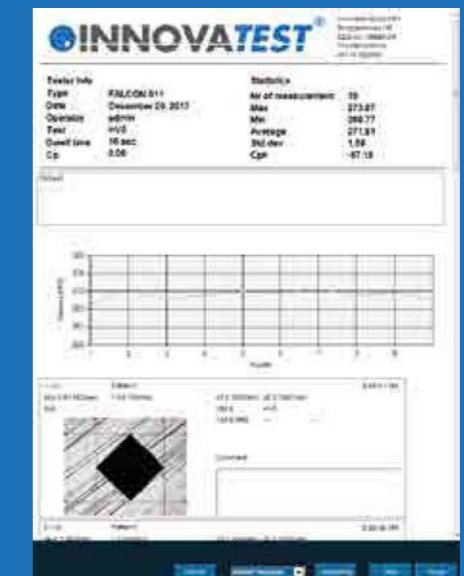



INCOMPREHENSIBLE POSSIBILITIES

The NEMESIS 9100 is specifically designed to use the large selection of fixtures and specimen holders they can be used on any of the stages and anvils. The frame size allows a large workspace accommodation. Regardless of the shape of a particular workpiece, the accessories list and corresponding software applications enable to test almost any component and part.

INNOVATEST

Tester Info: NEMESIS 9100
 Date: 24-1-2018
 Operator: Admin
 Dwelltime: 10 sec.
 Test: HV5
 Program: 5 46uk Op57 12.7x99 courbes FN14 Range

Statistics:
 Nr of measurement: 60
 Max: 156.78
 Min: 110.85
 Average: 133.12
 Standard Deviation: 13.01
 Range: 45.93

Gamma: 10007-104
 Hour: 4

HARDNESS DIAGRAM

Step	Time	Value	Unit	Pass/Fail	Go/No Go
124	125	108	HV0.05	Pass	Go
125	126	108	HV0.05	Pass	Go
126	127	108	HV0.05	Pass	Go
127	128	108	HV0.05	Pass	Go
128	129	108	HV0.05	Pass	Go
129	130	108	HV0.05	Pass	Go
130	131	108	HV0.05	Pass	Go
131	132	108	HV0.05	Pass	Go
132	133	108	HV0.05	Pass	Go
133	134	108	HV0.05	Pass	Go
134	135	108	HV0.05	Pass	Go
135	136	108	HV0.05	Pass	Go
136	137	108	HV0.05	Pass	Go
137	138	108	HV0.05	Pass	Go
138	139	108	HV0.05	Pass	Go
139	140	108	HV0.05	Pass	Go
140	141	108	HV0.05	Pass	Go
141	142	108	HV0.05	Pass	Go
142	143	108	HV0.05	Pass	Go
143	144	108	HV0.05	Pass	Go
144	145	108	HV0.05	Pass	Go
145	146	108	HV0.05	Pass	Go
146	147	108	HV0.05	Pass	Go
147	148	108	HV0.05	Pass	Go
148	149	108	HV0.05	Pass	Go
149	150	108	HV0.05	Pass	Go

AMMUNITION TESTING PATTERN CONFIGURATOR & REPORTING

This application is developed in close cooperation with special manufacturers of ammunition shells and casings. It allows single and multiple shell/casing testing according to the requirements in the industry. The fully automatic test procedure generates a detailed report, providing single readings and statistics with Go/No Go indication. This further includes sophisticated settings for re-measurement. For particular details please contact our sales department.



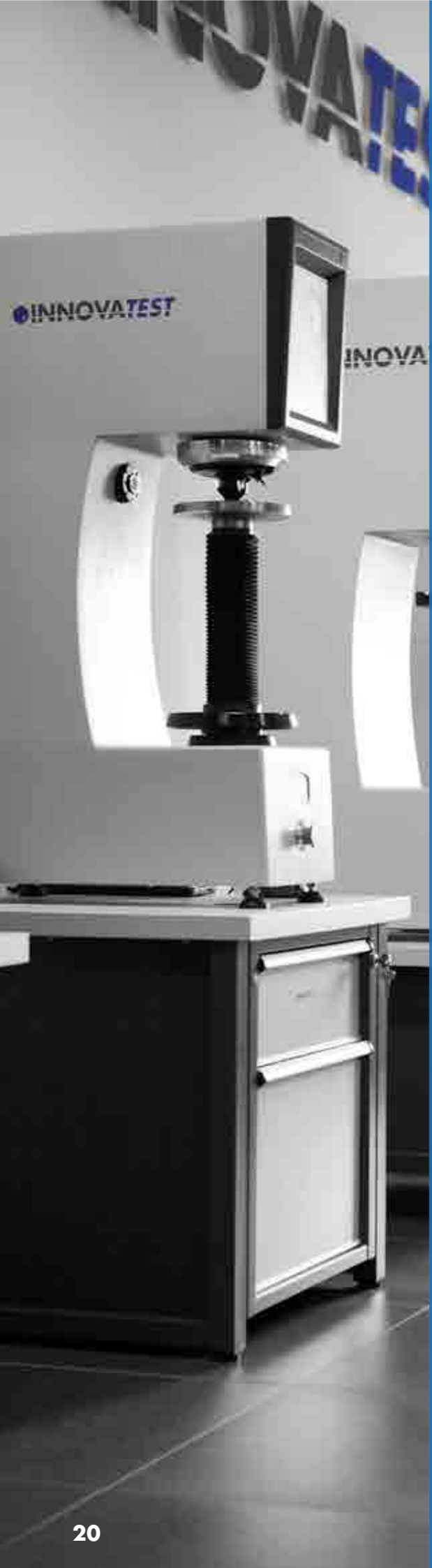

SUPPORT YOUR BEST TESTING RESULTS

With our rigid designed Bench stands

- Rock solid bench stands
- 100% retractable drawer, bearing guidance, max 100kg load. Rubber anti slip bottom
- Lockable cabinet, 300mm high
- Adjustable feet, (+/- 50mm height adjustable to reach ergonomic working position)
- Made of corrosion resistant zinc plated steel with RAL powder coating
- Carrying capacity of 400kg
- Top surface made of 50mm Plywood with 1.5mm chemical resistant plastic plating, edges made of shock resistant 3mm ABS side liner
- Industrial quality, for workshop or laboratory

Designed for hardness testing instruments, painted in INNOVATEST® RAL colors matching our testers.



UN-STAND/950 71 x 75 x 70 cm

ACCESSORIES

NEMESIS 9100

Schematic overview of the configuration options, standard and optional accessories

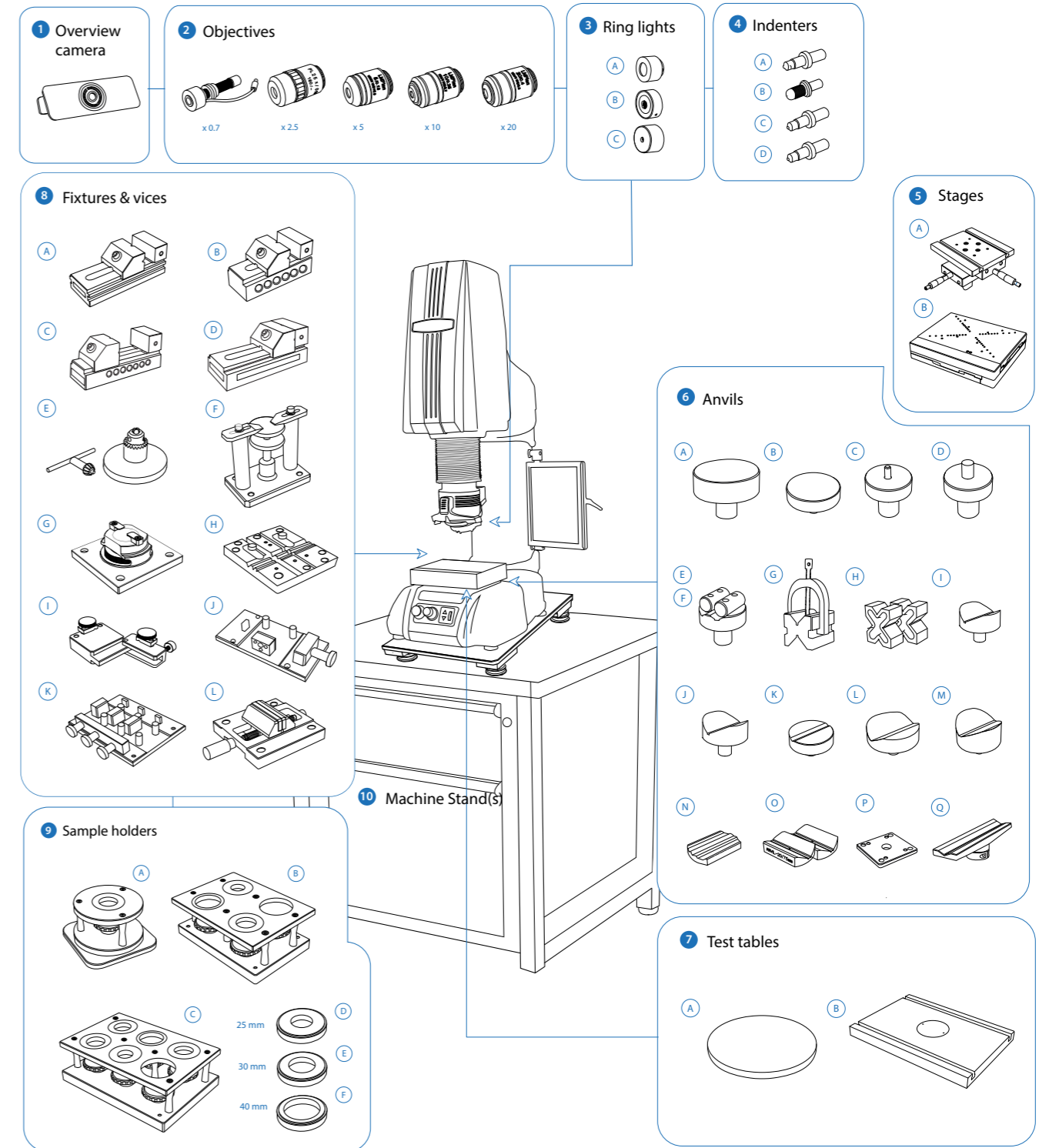

Not all accessories are displayed on this page. Full details can be found on the Order details page.

ORDER DETAILS

NEMESIS 9100



Universal hardness tester, 500gf - 250kgf	NEMESIS 9101	
Universal hardness tester, 200gf - 250kgf	NEMESIS 9102	
Universal hardness tester, 5kgf - 3000kgf	NEMESIS 9103	
Universal hardness tester, 200gf - 3000kgf	NEMESIS 9104	
High force extension 500kgf & 750kgf for Brinell and ball indentation (9102)	UN-HFE/01	
Plug & Play prepared, calibration, sea & airworthy packing in "non coniferous wood" material	P&PSEAPACK140	

ACCESSORIES

1	Overview Camera	Overview / Full view zoom camera + software functionality, field of view 40x30mm up to 210x160mm, Includes overview lights	SA-05-0019					
		2	Objectives	0.7x Objective for Brinell	AS9000-0,7OBJ	STANDARD		
				2.5x Long Working Distance objective	ASSUN-OBJ2.5X	STANDARD		
				5x Long Working Distance objective	ASSUN-OBJ5X			
				10x Long Working Distance objective	ASSUN-OBJ10X	STANDARD		
				20x Long Working Distance objective	ASSUN-OBJ20X			
3	Ring lights	A	Crystal™ Clear LED ring light, multi use for 0.7x objectives	SA-05-0020				
			B	Crystal™ Clear LED ring light, multi use for 2.5x objectives	SA-05-0021			
			C	Crystal™ Clear LED ring light, multi use for 5x objectives	SA-05-0022			
		4	Indenters	A	Rockwell C Diamond Indenter, ISO & ASTM certified	IN/6005		
					B	Brinell Indenter 1mm. Includes 1 carbide ball. Ø6.35mm. ISO & ASTM certified	IN/7000	
					Brinell Indenter 2.5mm. Includes 1 carbide ball. Ø6.35mm. ISO & ASTM certified	IN/7005		
				Brinell Indenter 5mm. Includes 1 carbide ball. Ø6.35mm. ISO & ASTM certified	IN/7010			
				Brinell Indenter 10mm. Includes 1 carbide ball. Ø6.35mm. ISO & ASTM certified	IN/7015			
				Rockwell Ball Indenter 1/16". Includes 1 carbide ball, ISO & ASTM certified	IN/7506			
				Rockwell Ball Indenter 1/8". Includes 1 carbide ball, ISO & ASTM certified	IN/7606			
				Rockwell Ball Indenter 1/4". Includes 1 carbide ball, ISO & ASTM certified	IN/7706			
				Rockwell Ball Indenter 1/2". Includes 1 carbide ball, ISO & ASTM certified	IN/7806			
5	Stages	C	Macro Vickers Indenter Ø6.35mm, ISO & ASTM certified	IN/8010				
			D	Macro Knoop Indenter Ø6.35mm, ISO & ASTM certified	IN/8220			
		A	Manual X-Y stage with analogue metric micrometers, 180x160mm Displacement: 25x25mm, scale 0.01mm, max load 300kg	UN-TESTTABLE/030				
			Motorized CNC X-Y stage, 257x188mm, total load up to 400Kgf max Displacement: 120x120mm, resolution 0.001 mm, repeatability +/-0.003mm	UN-XY571212TT				
			Motorized CNC X-Y stage, 307x208mm, total load up to 400Kgf max Displacement: 170x120mm, resolution 0.001mm, repeatability +/-0.003mm	UN-XY571712TT				
			Motorized CNC X-Y stage, 357x208mm, total load up to 400Kgf max Displacement: 220x120mm, resolution 0.001mm, repeatability +/- 0.003mm	UN-XY572212TT				
B	Motorized CNC X-Y stage, 337x238mm, total load up to 400Kgf max. Displacement: 200x150mm, resolution 0.001mm, repeatability +/- 0.003mm	UN-XY902015						
	Motorized CNC X-Y stage, 437x238mm, total load up to 450Kgf max. Displacement: 300x150mm, resolution 0.001mm, repeatability +/- 0.003mm	UN-XY903015						
	Motorized CNC X-Y stage, 630x238mm, total load up to 450Kgf max Displacement: 400x150mm, resolution 0.001mm, repeatability +/-0.003mm	UN-XY904015						

		Motorized CNC X-Y stage, 410x280mm, total load up to 4000Kgf max. Displacement: 200x150mm, resolution 0.001mm, repeatability +/- 0.008mm	UN-XY932015	
		Motorized CNC X-Y stage, 510x280mm, total load up to 4000Kgf max. Displacement: 300x150mm, resolution 0.001mm, repeatability +/- 0.008mm	UN-XY933015	
		Motorized CNC X-Y stage, 630x238mm, total load up to 4000Kgf max. Displacement: 400x150mm, resolution 0.001mm, repeatability +/- 0.008mm	UN-XY934015	
	Cable sets, Mounting & Connectivity for Motorized Stages	Dove tail mounting plate	CM-08-0033	
		Cable set for connecting CNC stage to embedded driver (1 set for 2-axis) 105cm	UN-XY2CABLENBS	
6	Anvils	A	Flat anvil 60mm	AS3000-19-04
		B	Flat anvil 80mm	UN-TESTTABLE/002
		C	Spot anvil 5mm	UN-ANVIL/010
		D	Spot anvil 10mm	UN-ANVIL/011
		E	Cylindrical V anvil 6-80mm	UN-CVANVIL680
		F	Cylindrical V anvil 50-200mm	UN-CVANVIL50200
		G	V block with bracket 40x40x50mm (LxBxH)	UN-VBLOCK404050
		H	Steel, cross type, (X) V-block 60x120x100mm 8-90mm pair	UN-CROSSBLOCK01
		I	V-anvil ø40mm 6-60mm	UN-ANVIL/005
		J	V-anvil ø63mm 10-100mm	UN-ANVIL/006
		K	V-Anvil ø80mm 3.3-20mm	UN-ANVIL/040
		L	V-Anvil ø80mm 15-80 mm	UN-ANVIL/045
		M	V-Anvil ø80mm 23-40 mm	UN-ANVIL/050
			Test table 100x100mm, V groove 20mm wide, 10mm deep	UN-TESTTABLE/040
		N	Small V-Anvil 3-20mm requires base plate (Requires Manual/Autom. X-Y stage)	UN-ANVILSV/105
		O	Large V-Anvil 20-75mm requires base plate (Requires Manual/Autom. X-Y stage)	UN-ANVILLV/106
		P	Base plate for V-anvils un-anvilsv/105 & 106	UN-VANVILBASEPL
		Q	Extra long V-Anvil (Ø10 - Ø100)	CM-08-0186
	Clamping, Locking & Fixing adapters	Quick change anvil base (required for mounting testing tables, anvils)	AS5000-450	
		Lock flange	UN-XYZ BUSH50	
		Mounting plate for lock flange	UN-XYZ30FP50-55	
7	Test Tables	Lock flange	AS9000-21-01	
		A	Testing table Ø200mm (61 - 65HRC) requires lock flange	CM-08-0194
			Testing table flat ø200mm, screwfix	UN-TESTTABLE/010
			Testing table flat ø235mm, screwfix	UN-TESTTABLE/012
		B	Large flat surface testing table 350x250mm, thickness 30mm with 2 T-slots, for large components	UN-TESTTABLE/015
			Large flat surface testing table 450x350mm, thickness 35mm with 2 T-slots, for large components	UN-TESTTABLE/016
8	Fixtures and Vices	A	Polished precision vice with lock down system, jaw width 25mm, opens 20mm	UN-VICE/210
		B	Polished precision vice with lock down system, jaw width 36mm, opens 42mm	UN-VICE/215
		C	Polished precision vice with lock down system, jaw width 48mm, opens 75mm	UN-VICE/220

ACCESSORIES

	D	Polished precision vice with lock down system, jaw width 75mm, opens 100mm	UN-VICE/230
	E	Axle chuck 500 series for cylinder parts, dia. 0.4mm to 5mm	UN-AXLECHUCK
	F	Universal Clamp & Leveling Device	UN-CLAMP/105
	G	Thin metal clamp	UN-CLAMP/115
	H	V groove clamp for small round parts dia.0.8-5mm (not suitable for test forces over 62.5kg)	UN-VGROOVE- CLAMP
	I	Wire Testing Fixture for specimen dia. 0.8-3.5mm	UN-WIRE/105
	J	JOMINY Fixture, for 1 quench end test sample, quick release function	UN-JOMFIX1
	K	JOMINY Fixture, for 3 quench end test sample, quick release function	UN-JOMFIX3
	L	Small parts vice jaw width 55mm, open 50mm, self centering	UN-VICE/115
9	Sample Holders		
	A	1 position sample holder, for 1 embedded sample, diameter 50mm or 2"	UN-ESH1
	B	4 position sample holder, for max. 4 embedded samples, diameter 50mm or 2"	UN-ESH4
	C	6 position sample holder, for max. 6 embedded samples, diameter 50mm or 2"	UN-ESH6
	D	1 insert reduction ring 25mm	UN-ESHI25
	E	1 insert reduction ring 30mm	UN-ESHI30
	F	1 insert reduction ring 40mm	UN-ESHI40
		1 insert reduction ring 1"	UN-ESHI1
		1 insert reduction ring 1 1/4"	UN-ESHI125
		1 insert reduction ring 1,5"	UN-ESHI15
10	Machine Stand	Cabinet test table with drawer for hardness testers 71x75x70cm	UN-STAND/950
		Seaworthy packing box for 950/960	PACK/100
	Vibration Isolation	Passive vibration isolation stage, broad spectrum	UN-AVS-300
	Printer	Laser Printer	UN-PRINT
	ISO/ASTM Verification	BRINELL direct and indirect verification/calibration & certification in compliance with ISO & ASTM, NADCAP. Includes direct force and indirect verification report (block readings), GR & R report, flat fee for selected common scales, per scale.	CALCEFRDW/1B
		ROCKWELL direct and indirect verification/calibration & certification in compliance with ISO & ASTM, NADCAP. Includes direct force and indirect verification report (block readings), GR & R report, flat fee for selected common scales, per scale.	CALCEFRDW/1R
		VICKERS direct and indirect verification/calibration & certification in compliance with ISO & ASTM, NADCAP. Includes direct force and indirect verification report (block readings), GR & R report, flat fee for selected common scales, per scale.	CALCEFRDW/1V
		KNOOP direct and indirect verification/calibration & certification in compliance with ISO & ASTM, NADCAP. Includes direct force and indirect verification report (block readings), GR & R report, flat fee for selected common scales, per scale.	CALCEFRDW/1K
	Cover	Machine cover 800x800x1450mm	UN-COVER7
	Joystick	3-axis joystick, with fine adjustment and dynamic axis control	UN-JOYSTICK1

OVERVIEW CAMERA



SA-05-0019

OBJECTIVES



RING LIGHTS



INDENTERS



STAGES



ANVILS



TEST TABLES



FIXTURES AND VICES

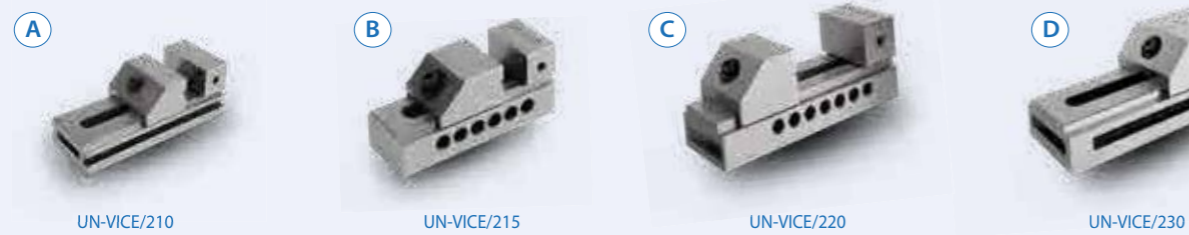

FIXTURES AND VICES



SAMPLE HOLDERS



MACHINE STANDS



VIBRATION ISOLATION STAGE



ORDER DETAILS

SOFTWARE

Additional Software	Automatic measurement	UN-AUTOM	STANDARD
	Automatic focussing	UN-AUTOFOC	STANDARD
	Report configurator	UN-REPORTA	STANDARD
	Snapshot function	UN-SNAPSH	STANDARD
	Advanced 3 axis coordinate & free style indent pattern configurator, for motorized stage only	UN-TESTPAT01	
	Advanced 3 axis coordinate & free style indent pattern configurator, + CHD, SHD, NHD and edge detection, (supports manual & digital micrometer stages only)	UN-TESTPAT02	
	KiC crack detection under load. Palmqvist & Median / Radial fracture toughness	UN-CRKPAP	
	Automatic Contour scanning	UN-CSCAN	
	2D / 3D hardness scanning (mapping, includes automatic contour scanning)	UN-CSCAN2D3D	
	Drawing and measuring (distance & angles) application	UN-DRMEAS	
	Automatic edge detection	UN-EDGEDTC	
	Force depth/time diagram	UN-FDDIAGR	
	ISO 898-1 screw thread measurement of (de)-carbonized part. Requires UN-CSCAN	UN-ISO898/1	
	ISO-2702 tap screw thread measurement	UN-ISO2702	
	User level management	UN-LEVMAN	STANDARD
	Manual & automatic on-screen measurement	UN-MANM	STANDARD
	CHD, SHD, NHD configurator & graphic interface for analogue and digital micro meter stage only (not including full pattern editor)	UN-MCHD	
	CHD, SHD, NHD configurator & graphic interface requires: indent pattern configurator (TESTPAT01)	UN-PATCHD	
	Q-DAS Certified connectivity protocol	UN-QDAS	
	Advanced 3-axis communication protocol for robotic systems	UN-REMC	
	ISO bullets casings pattern configurator and reporting system	UN-SHELLCONF	
	ISO 9015 Weld pattern configurator (automatic weld pattern configurator), requires overview camera or AS9000-0.7OBJ	UN-WELDPAT	
	Virtual Joystick, on screen		STANDARD

Connectivity Plus	Powerfull External Intel Core i9 PC, with 16gb RAM, and 512gb SSD drive (or better) Windows 10 pre-installed, IMPRESSIONS™ tester work flow software INNOVATEST recommends Embedded Industrial computers with DeepFreeze enabled.	UN-SYSPCIMP01	
	Bluetooth connectivity	UN-BTADAPT	
	Utility software; Import test results in MS applications like Excel	UN-SW/905	
	USB to USB null modem cable 2.5M	BE-99-0025	
	Wireless system Keyboard & wireless mouse	UN-SKBSET	STANDARD



SPECIFICATIONS

HARDNESS SCALES

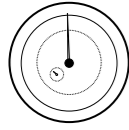
	ROCKWELL EN-ISO 6508 ASTM E-18 JIS Z 2245	Regular Rockwell scales; Pre Load 10kgf, Main Load 60kgf 100kgf 150kgf A B C D E F G H K L M P R S V Superficial Rockwell scales; Pre Load 3kgf, Main Load 15kgf 30kgf 45kgf 15N 30N 45N 15T 30T 45T 15W 30W 45W 15X 30X 45X 15Y 30Y 45Y
	VICKERS ISO 6507 ASTM E384, E92 JIS B 7725	HV0.2 HV0.3 HV0.5 HV1 HV2 HV2.5 HV3 HV4 HV5 HV10 HV20 HV25 HV30 HV40 HV50 HV100 HV120 HV150
	Kic Fracture toughness	All Vickers forces & scales
	KNOOP ISO 4545 ASTM E92 JIS Z 2251	HK0.2 HK0.3 HK0.5 HK1 HK2 HK5
	BRINELL ISO 6506, ASTM E10 JIS Z 2243	HBW1/1 HBW1/1.25 HBW1/2.5 HBW1/5 HBW1/10 HBW1/30 HBW2.5/6.25 HBW2.5/7.8125 HBW2.5/15.625 HBW2.5/31.25 HBW2.5/62.5 HBW2.5/187.5 HBW5/25 HBW5/31.5 HBW5/62.5 HBW5/125 HBW5/250 HBW5/750 HBW10/100 HBW10/125 HBW10/250 HBW10/500 HBW10/1000 HBW10/1500 HBW10/3000
	HVD (HVT) VDI/VDE 2616-1	HV5 HV10 HV20 HV30 HV50 HV100 HV120
	HBD (HBT) VDI/VDE 2616-1	HBW1/5 HBW1/10 HBW1/30 HBW2.5/6.25 HBW2.5/15.625 HBW2.5/31.25 HBW2.5/62.5 HBW2.5/187.5 HBW5/25 HBW5/125 HBW5/250 HBW5/750 HBW10/100 HBW10/500 HBW10/1000 HBW10/1500 HBW10/3000
	PLASTIC ISO 2039	49 N, 132 N, 358 N, 961 N
	CARBON	HR 2.5/7 HR 5/7 HR 5/15 HR 5/20 HR 5/40 HR 5/60 HR 5/100 HR 5/150 HR 10/20 HR 10/40 HR 10/60 HR10/100 HR 10/150
	CONVERSIONS	Conversion to other hardness scales according to ASTM E140, ISO 18265, GB/T 1172

TEST FORCE

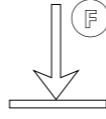
	Force application	Multi-load cell, closed loop, force feedback system
	Test forces	0.2kgf – 3000kgf
	Force range per model	NEMESIS 9101 500gf - 250kgf NEMESIS 9102 200gf - 250kgf NEMESIS 9103 5kgf - 3000kgf NEMESIS 9104 200gf - 3000kgf
	Test force tolerance	< 0.25% for test force 100gf to 250kgf < 0.25% for test force 250gf to 3000kgf < 0.5% for test force below 100gf
	Dwell time settings	Default 10 seconds, user defined. Up to 999 seconds

TURRET

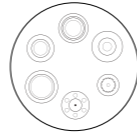
	Motorized turret	Ultra-fast, 8 position turret, 3 indenter positions, 3 objective positions
	Objectives	Long working distance 0.7x, 2.5x, 5x, 10x, 20x
	Indenters	Certified indenters (ISO/ASTM) available at choice
	Camera 1 (objective)	18 Mpx, HD, 4K+, Machine vision system
	Camera 2 (overview)	Full HD, Full Color, Optical zoom system, variable FOV 40 x 30mm - 210 x 160mm
	Class 2 Laser	Positioning system (standard)

SYSTEM

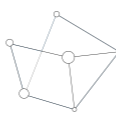
	Electronic system Standard (Recommended)	High performance embedded controller, i7, mSSD 120 GBxx, MS Windows® 10 operated, up to 8 years* INNOVATEST warranty
	Electronic system (Optional)	High performance external controller, i9, mSSD 120 GBxx, MS Windows® 10 operated, 1 year factory warranty
	CNC support	5 Axis CNC controller (for motorized stages) or stage accessories
	Screen(s)	15" portrait mode capacitive touchscreen, second screen option
	Display resolution	0.01 HV, HK, HB, HR
	Statistics	Total test, max, min, average, range, standard deviation, All in real time after each test
	Hardness conversion	Rockwell, Rockwell Superficial, Vickers, Brinell, Knoop, Leeb & Tensile
	Software	IMPRESSIONS™ V2, work flow system & tester control
	Data storage capacity	Internal and external mSSD, SSD or HDD
	Data output	XML, CSV, Certified for Q-DAS (optional)
	Connectivity	4 USB ports, RJ45 Ethernet LAN, W-LAN, RS-232, Blue Tooth, 5 Axis CNC & motorized XY-stage connector, Dual HDMI screen connectors
	Printer	A4, A3 full color laser printer (optional)

* Check individual warranty conditions

SPECIFICATIONS

GENERAL

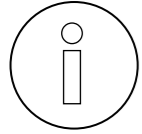

Machine dimension	1489 mm x 506 mm x 701 mm
Machine weight	280 kg
Workpiece accommodation	320mm (H) x 225mm (D)
Power supply	100VAC to 240VAC, 50/60Hz, single phase
Operating temperature	10°C to 50°C
Power consumption	100W
Humidity	10% to 90%, non-condensing
Noise emission	< 70 db(A)

TECHNICAL DRAWINGS

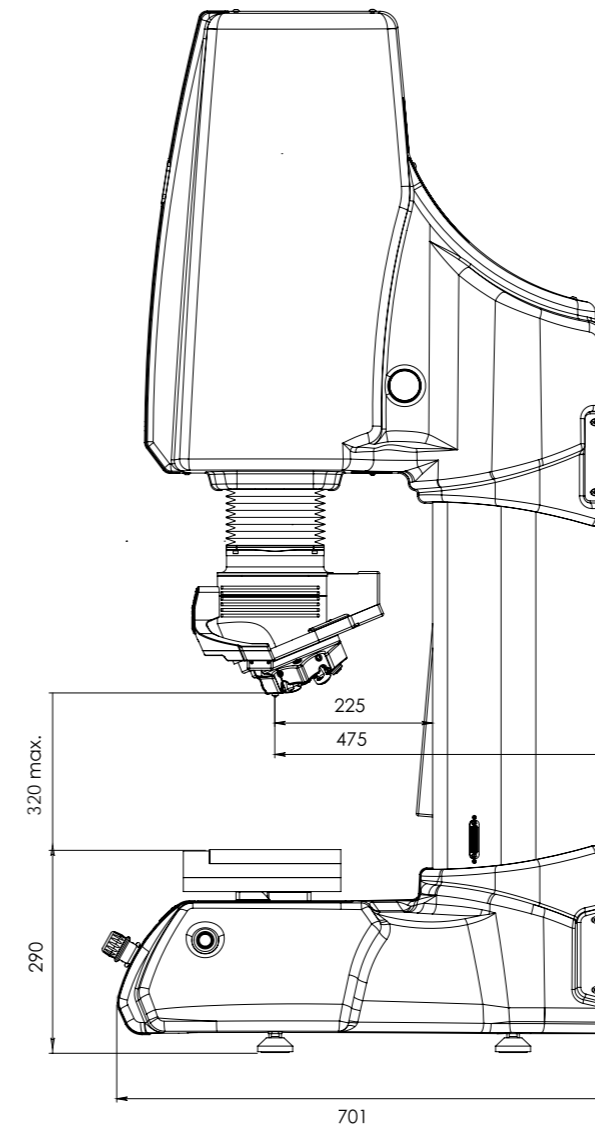

All dimensions in these drawings are in mm, approximate. Working heights and or workpiece accommodation varies depending on the stages and stage accessories used.

Please contact our sales department for more details.

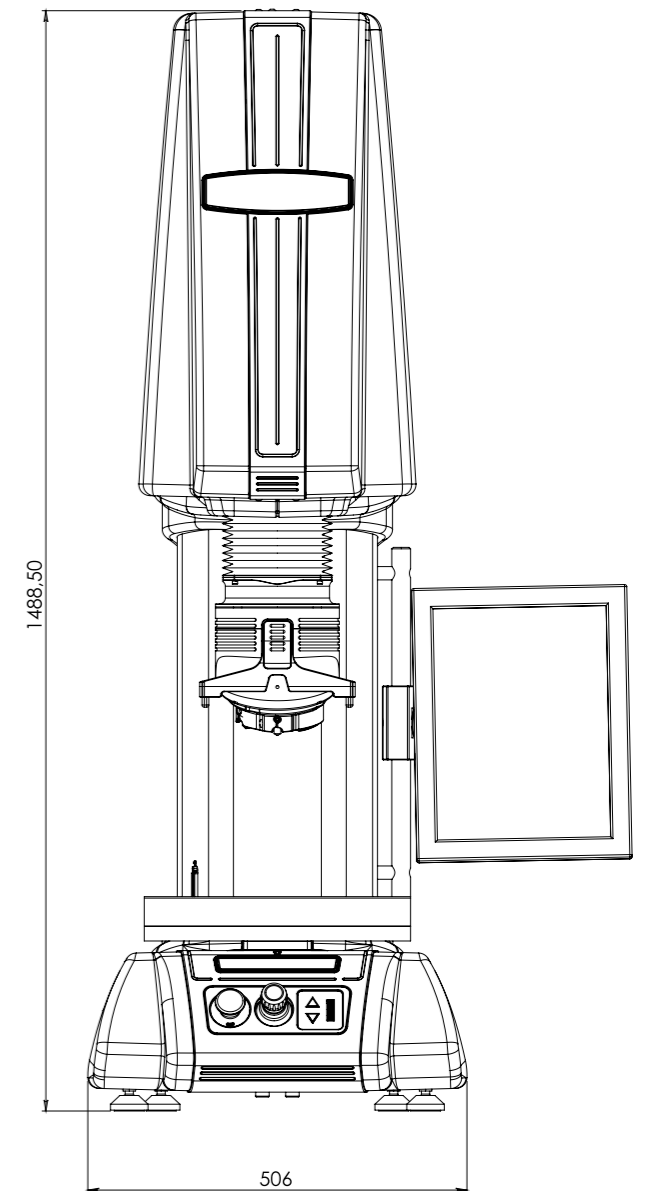

OTHER MODELS IN THE UNIVERSAL RANGE



NEXUS 605U

Fully automatic, load cell, Closed loop, force feedback universal hardness tester with electronic micrometer or analogue eyepiece. I-TOUCH™, 6.5" full color touchscreen.
See brochure B19N605U/XX



VERZUS 750U

Fully automatic, load cell, Closed loop, force feedback universal hardness tester with electronic micrometer or analogue eyepiece. IMPRESSIONS™ 8.5" full color touchscreen.
See brochure B19V750U/XX



FENIX 300U

Load Cell, Closed loop, force feedback, test force application system Universal hardness tester with I-TOUCH™ system.
See brochure B20F300/XX



NEXUS 8100XL

Heavy duty fully automatic, load cell, Closed loop, force feedback universal hardness tester with full HD optical zoom stage overview camera, IMPRESSIONS™ 15" full color touchscreen.
See brochure B19N8100/XX



NEMESIS 9600

Heavy duty fully automatic, load cell, Closed loop, force feedback universal hardness tester with full HD optical zoom stage overview camera, IMPRESSIONS™ 15" full color touchscreen.
See brochure B19N9600/XX



NEXUS 7700

Fully automatic, load cell, Closed loop, force feedback universal hardness tester with full HD optical zoom stage overview camera, IMPRESSIONS™ 12" full color touchscreen.
See brochure B19N7700/XX



NEMESIS 5100

Multi Load Cell, Closed loop Fully automatic, 8 position turret Rockwell, Superficial Rockwell, Micro/Macro Vickers, Knoop & Brinell Hardness testers Descending test head, fixed work piece position
See brochure B18N5100/XX



NEXUS 8100

Heavy duty fully automatic, load cell, Closed loop, force feedback universal hardness tester with full HD optical zoom stage overview camera, IMPRESSIONS™ 15" full color touchscreen.
See brochure B19N8100/XX

Distributor :

CORPORATE HEAD OFFICE

INNOVATEST Europe BV

Manufacturing, Distribution & Service

Borgharenweg 140
6222 AA MAASTRICHT
The Netherlands

Phone: +31 43 3520060

Fax: +31 43 3631168

info@innovatest-europe.com

www.innovatest-europe.com

INNOVATEST Deutschland GmbH Sales & Service

Phone: +49 245 670 59 500
info@innovatest-deutschland.com
www.innovatest-deutschland.com

INNOVATEST Polska sp. z.o.o Sales & Service

Phone: +48 697 099 826
info@innovatest-polska.pl
www.innovatest-polska.pl

INNOVATEST Shanghai Co., Ltd. Sales & Service

Phone: +86 21 60906200
info@innovatest-shanghai.com
www.innovatest-shanghai.com

INNOVATEST Japan Co., Ltd. Sales & Service

Phone: +81 3 3527 3092
info@innovatest-japan.com
www.innovatest-japan.com

INNOVATEST USA Company Sales & Service

Phone: +1 267 317 4300
info@innovatest-usa.com
www.innovatest-usa.com

INNOVATEST South East Asia Sales & Service

Phone: +65 6451 1123
info@innovatest-singapore.com
www.innovatest-singapore.com